

R-2 R-1

E

50*50

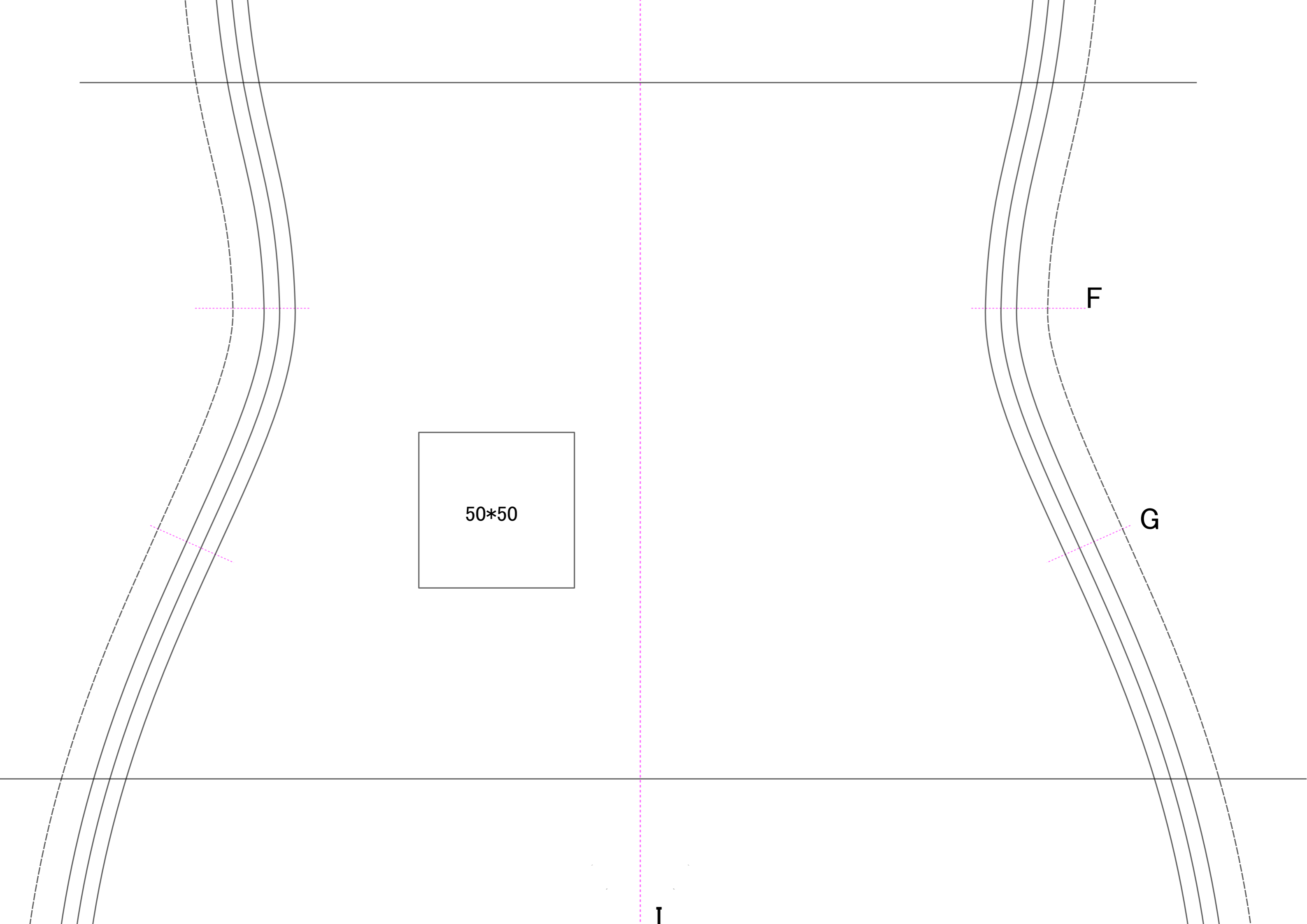

50*50

F

G

I

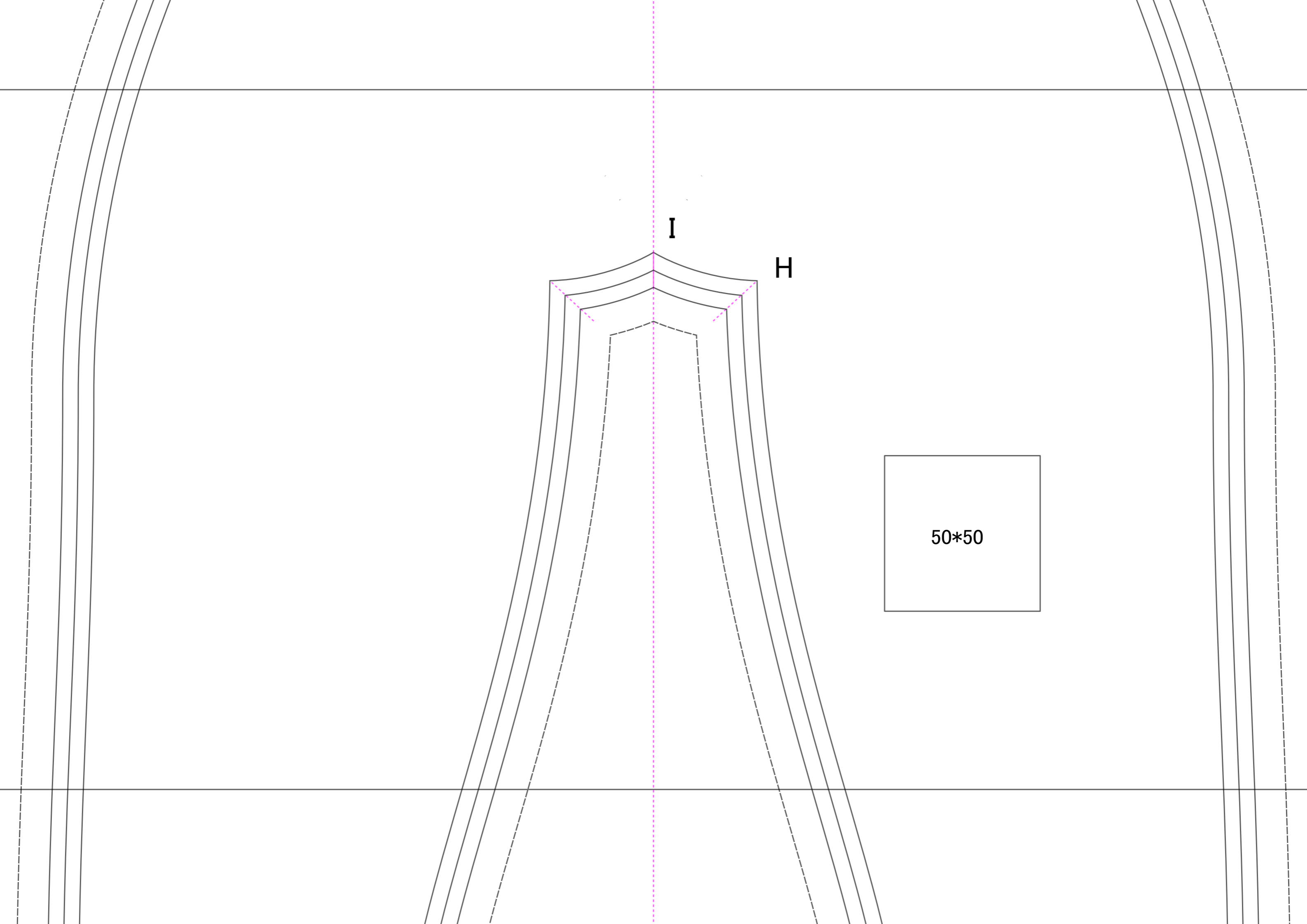

I

H

50*50



50*50

50*50

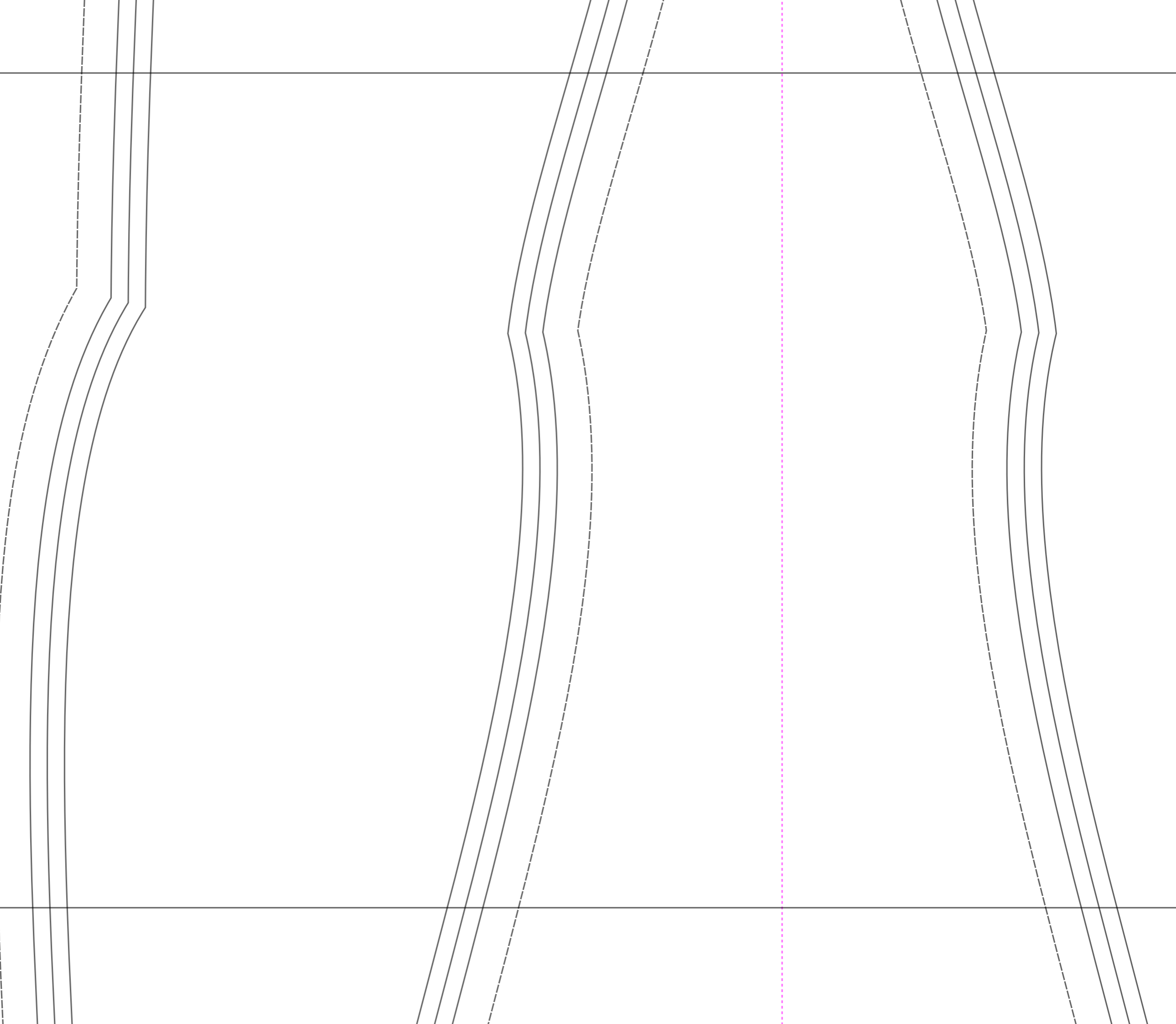
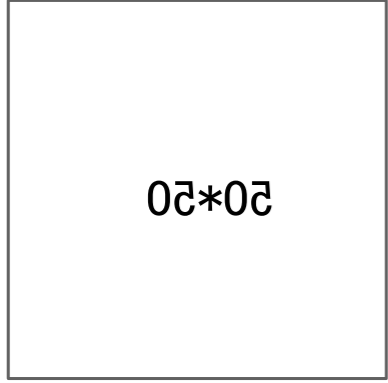

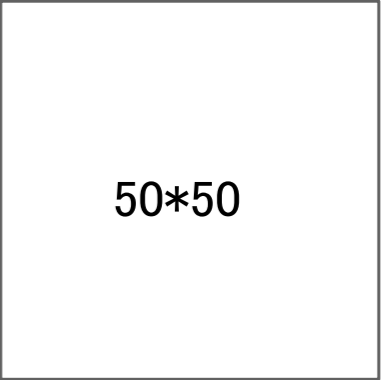

L3~L5は
切れ込みを入れる

骨を入れる場合は
このダーツは不要

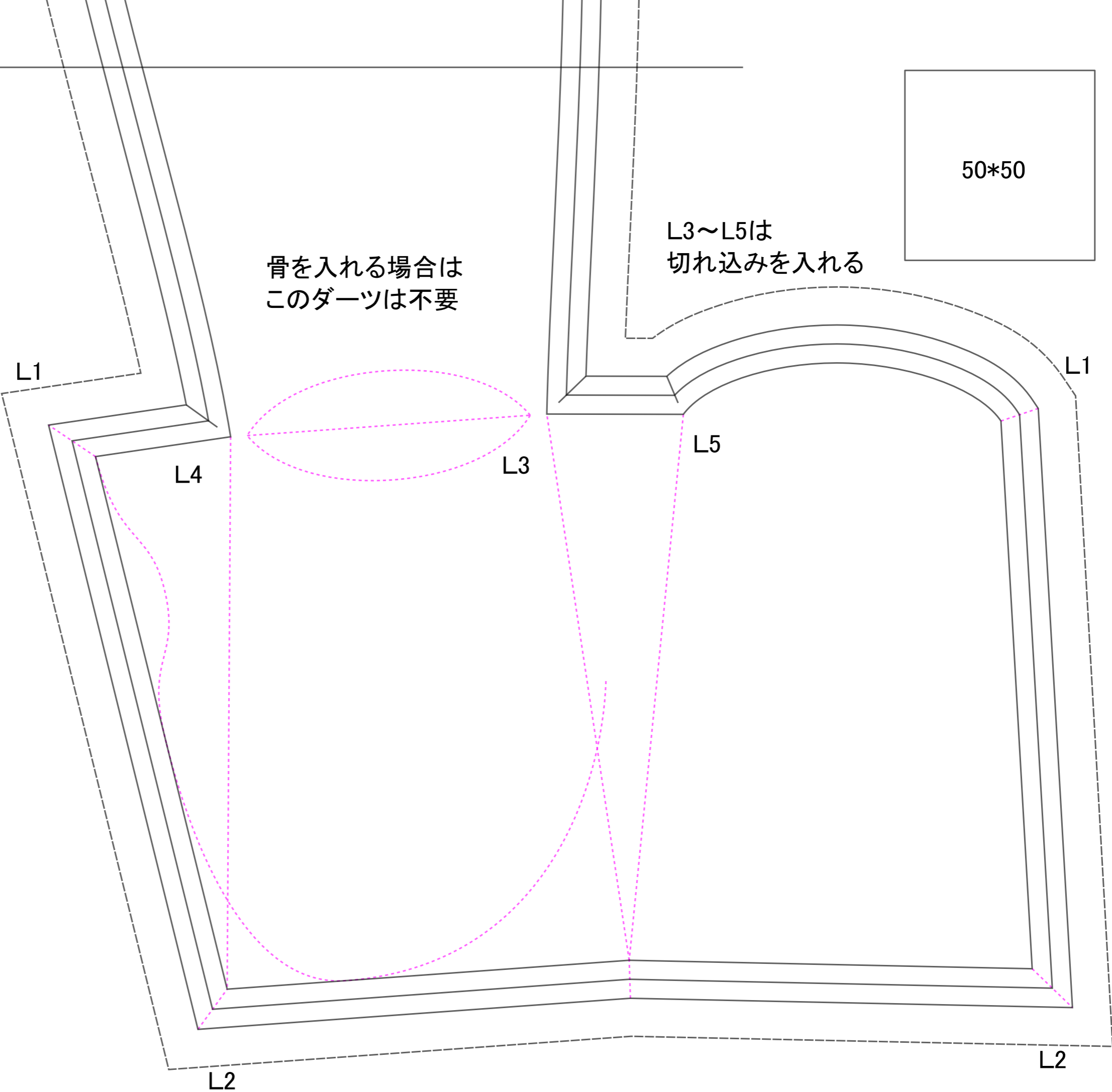

20*20

お3~お1
る人きやん人時

お合器る人き骨
要不おびーのこ

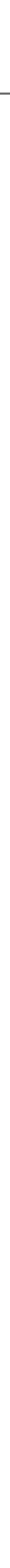
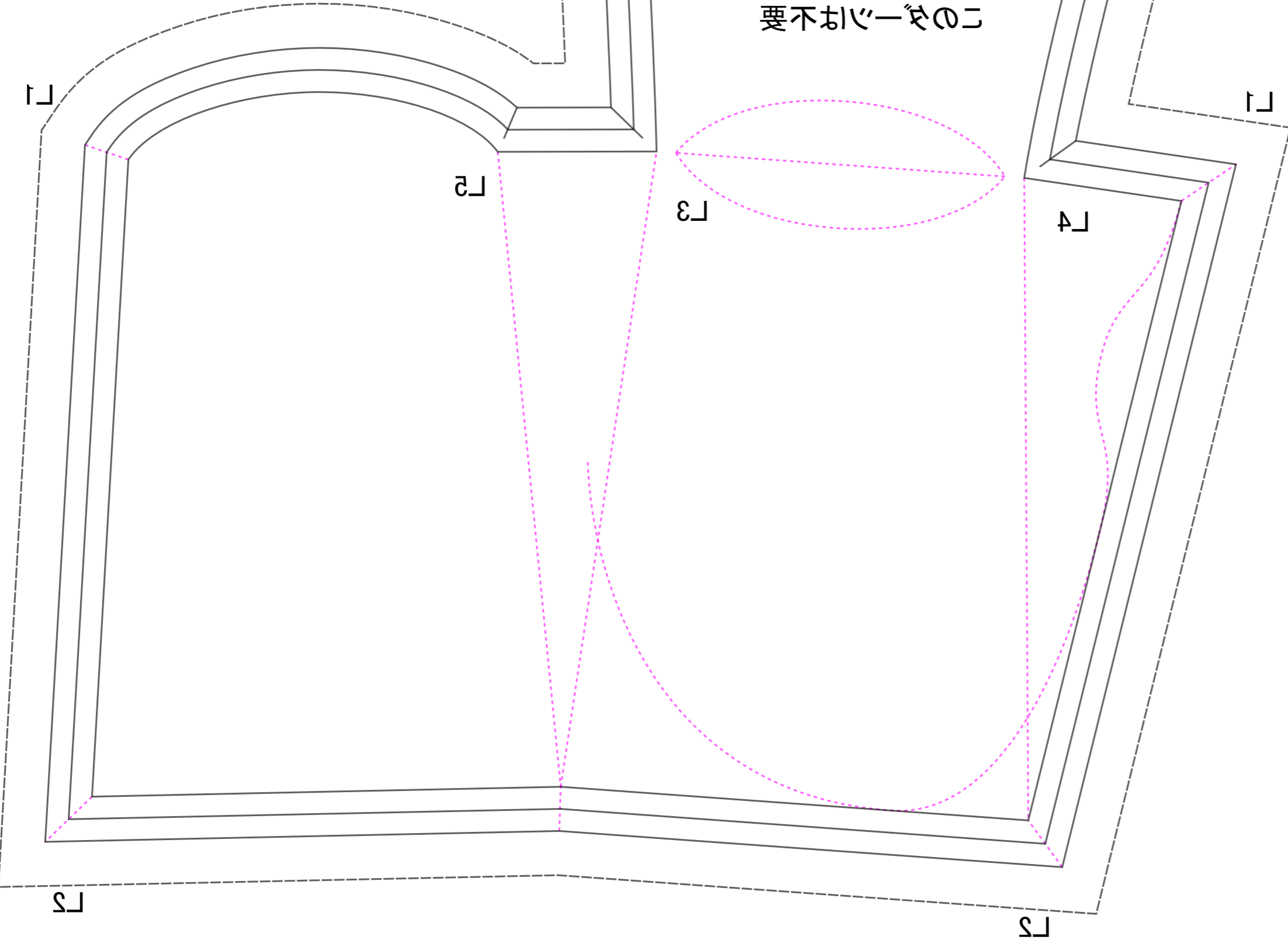

50*50

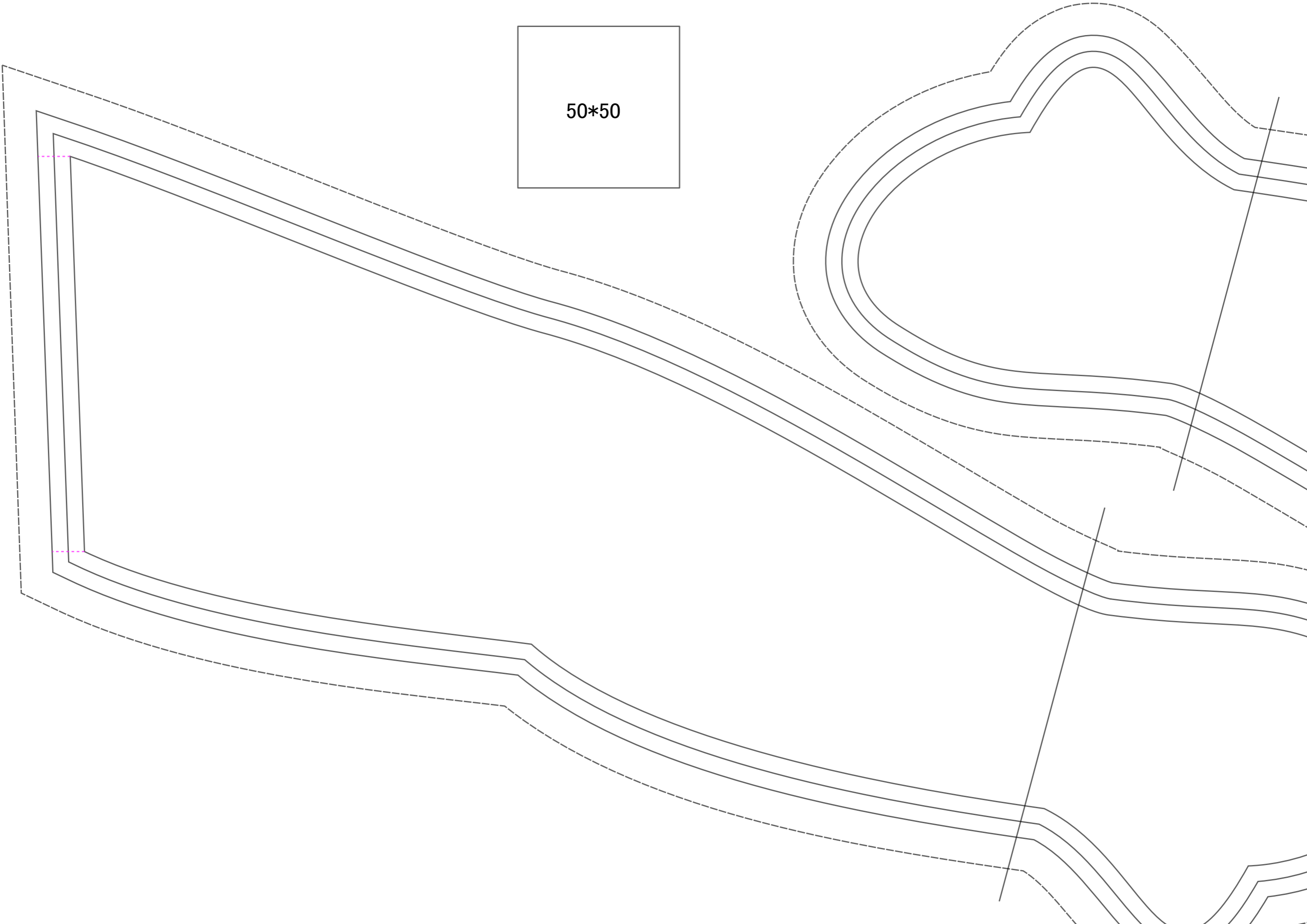

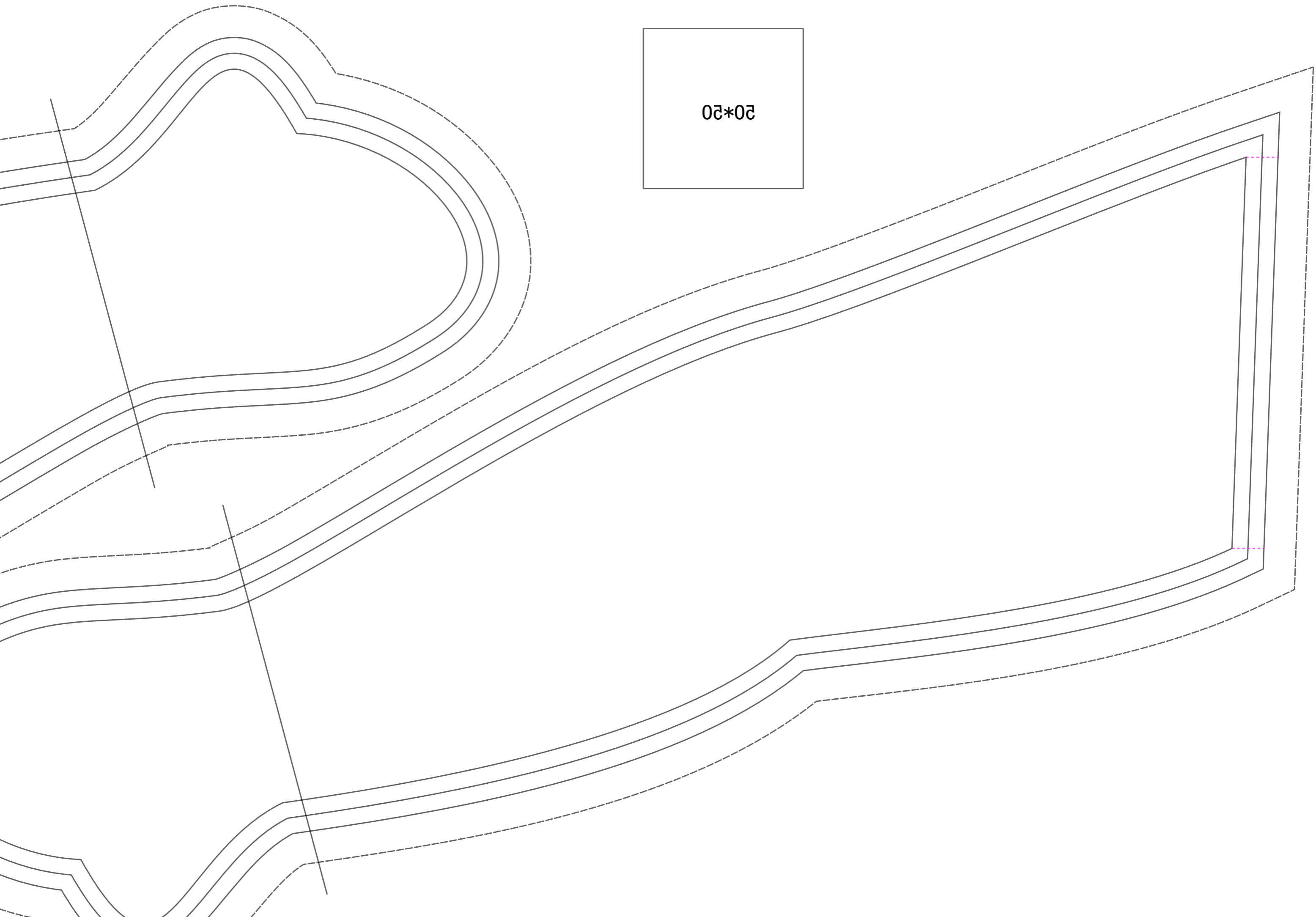

20*20